

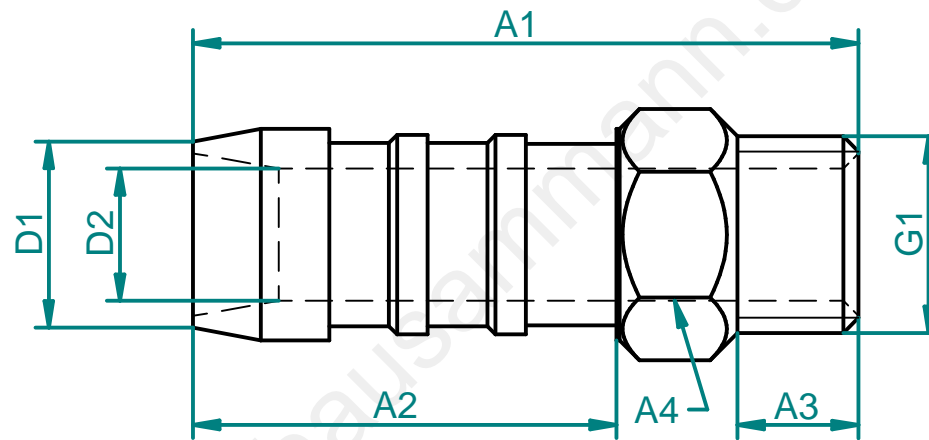

General tolerances ISO 2768-m						Index	Date	Visum	Modification	Index	Date	Visum	Modification
Basic-size	...6	> 6 ...30	> 30 ...120	>120 ...400	> 400 ...1000								
medium	±0.1	±0.2	±0.3	±0.5	±0.8								



Specifications points D,K,H	
D= doc.points	
K= critical	
H= main	

Accord-draw.no.: Origin-draw.no.: Replacement for:	Material:					
	Kunststoff					
	Scale					
		Date	Visum	Phone		
plotted	17.10.11	E.Z				
checked						
		38.135	Solid Edge	Format	Index	
		A4			00	
© 2010, Für dieses Dokument behalten wir uns alle Rechte vor.		© 2 010, Nous nous reservons tous les droits sur ce document		© 2 010, We reserve all rights in connection with this document		